

life  smart™



**OWNER'S MANUAL 60Hz  
Acrylic Spas**

# LIFESMART OWNER'S MANUAL

## 115/230V Systems

### Owner's Record

#### Locating the Spa Serial Number:

The spa serial number label is located inside the equipment compartment. Equipment compartment access panel is below the spas topside control panel. Write your spa information in the space provided.

DATE PURCHASED:	
PURCHASED FROM:	
SPA MODEL:	
SERIAL NUMBER:	See Page 7

Please read this Owner's Manual carefully, as it is designed to provide you with the information you will need to ensure the safe, secure use of your spa.

**IMPORTANT: LIFESMART** reserves the right to change specifications and/or design without notification and without any obligation.

#### SPA SPECIFICATIONS

Model	Spa Seating	Length	Width	Height	Dry Weight	Water Capacity	Electrical 60Hz
Willow <i>LSA-510L</i>	3 person	66" (168 cm)	84" (213 cm)	34" (86 cm)	<i>lbs / kg</i>	<i>gal / l</i>	<i>115 or 230V</i>
Acacia L <i>LSA-620L</i>	5 person	78" (198 cm)	78" (198 cm)	34" (86 cm)	<i>683 lbs / 310 kg</i>	<i>255 gal / 965 l</i>	<i>230V</i>
Acacia NL <i>LSA-620</i>	7 person	78" (198 cm)	78" (198 cm)	34" (86 cm)	<i>681 lbs / 309 kg</i>	<i>268 gal / 1,014 l</i>	<i>230V</i>
Palmetto L <i>LSA-720L</i>	6 person	84" (213 cm)	84" (213 cm)	34" (86 cm)	<i>807 lbs / 366 kg</i>	<i>322 gal / 1,219 l</i>	<i>230V</i>
Palmetto NL <i>LSA-720</i>	7 person	84" (213 cm)	84" (213 cm)	34" (86 cm)	<i>805 lbs / 365 kg</i>	<i>346 gal / 1,310 l</i>	<i>230V</i>

#### CAUTION

##### DO NOT OPERATE SPA BEFORE READING THIS MANUAL

Failure to read this manual and follow its instructions may result in unsafe operation and or permanent damage to your portable spa.

Most cities, counties, states, and countries require permits for exterior construction and electrical circuits. In addition, some communities have codes requiring residential barriers such as fencing and/or self-closing gates on the property to prevent unsupervised access to a pool or spa by children. Be sure to check with your local agencies for specific requirements.

If you need additional information and/or assistance, please contact Customer Service at 888-961-7727 Ext. 8440 or at [ahsservice@watkinsmfg.com](mailto:ahsservice@watkinsmfg.com).

# TABLE OF CONTENTS

## CONTENTS

### SAFETY INFORMATION

IMPORTANT SAFETY INSTRUCTIONS	1
IMPORTANT SPA INSTRUCTIONS	4

### INSTALLATION

PLANNING A LOCATION FOR YOUR SPA	5
PLACING THE SPA	6

### EQUIPMENT ACCESS

EQUIPMENT ACCESS PANEL	7
------------------------	---

### ELECTRICAL REQUIREMENTS

ELECTRICAL REQUIREMENT	8
ELECTRICAL WIRING 115V-230V CONVERSION	9
ELECTRICAL WIRING DIAGRAM 230V	10

### CONTROL PANEL OPERATION

DISPLAY OVERVIEW	11
JETS OPERATION	11
MULTI COLOR LED LIGHT	11
TEMPERATURE ADJUSTMENT	12
FILTER CYCLES	13
RESTRICTING OPERATION	14
OTHER FUNCTION	15

### COMPONENT OPERATION

SPA COMPONENT OPERATION	16
-------------------------	----

### FILL-UP AND START-UP INSTRUCTIONS

FILLING THE SPA WITH WATER	17
APPLYING POWER	17

## CONTENTS

### ADDING START-UP CHEMICALS

WATER CHEMISTRY GUIDELINES	18
----------------------------	----

### SPA MAINTENANCE

FILTER CARTRIDGE MAINTENANCE	19
SURFACE CARE	20
COVER CARE	20
CABINET CARE	20
REPLACEMENT PARTS	20

### DRAINING OR WINTERIZING

DRAINING YOUR SPA	21
WINTERIZING YOUR SPA	21

### TROUBLESHOOTING PROCEDURES

NO COMPONENT OPERATION	22
PUMP DOES NOT OPERATE, BUT THE LIGHT DOES	22
POOR JET ACTION	22
WATER IS TOO HOT	22

### TROUBLESHOOTING

TROUBLESHOOTING	23
-----------------	----

### REPLACEMENT PARTS

REPLACEMENT SPA PARTS	24
-----------------------	----

## IMPORTANT SAFETY INSTRUCTIONS

### READ AND FOLLOW ALL INSTRUCTIONS

#### AVOIDING THE RISK TO CHILDREN

##### **DANGER:**

- **RISK OF CHILD DROWNING:** Extreme caution must be exercised to prevent unauthorized access by children. To avoid accidents, ensure that children cannot use a spa unless they are supervised at all times. Children should be supervised to not use the spa as a toy.

##### **WARNING:**

- To reduce the risk of injury, do not permit children to use this product unless they are closely supervised at all times.
- To reduce the risk of injury, lower water temperatures are recommended for young children. Children are especially sensitive to hot water.

##### **DO:**

- Make sure you always lock the child resistant locks after using the spa for your children's safety. Every spa is equipped with a locking cover that meets the ASTM F1346-91 Standard for Safety Covers.
- Test the water temperature with your hand before allowing your child to enter the spa to be sure that it's comfortable. Children are especially sensitive to hot water.
- Remind children that wet surfaces can be very slippery. Make sure that the children are careful when entering or exiting the spa.

##### **DON'T:**

- Allow children to climb onto the spa cover.
- Allow children to have unsupervised access to the spa.

## AVOIDING THE RISK OF ELECTROCUTION

### RISK OF ELECTROCUTION:

- Connect only to a grounded source.
- Do not bury the power cord. A buried power cord may result in death or serious personal injury due to electrocution if direct burial-type cable is not used, or if improper digging occurs.
- A ground terminal (pressure wire connector) is provided on the control box inside the unit to permit connection of a minimum No. 10 AWG solid copper bonding conductor between this point and any metal equipment, metal water pipe, metal enclosures of electrical equipment, or conduit within 5 feet (1.5 m) of the unit as needed to comply with local requirements.

##### **WARNING:**

- Your spa must use a Ground Fault Circuit Interrupter for user and equipment protection. To ensure proper operation of this important safety device, test according to the following instructions per electrical configuration.

### 115 VOLT, CORD-CONNECTED MODELS:

- The GFCI is located at the end of the power cord. Before each use, with the unit operating, push the TEST button. The unit should stop operating and the GFCI power indicator will go out. Wait 30 seconds and then reset the GFCI by pushing the RESET button. The GFCI power indicator will turn on, restoring power to the spa. If the interrupter does not perform in this manner, there may be an electrical malfunction and with it, the possibility of an electric shock. Disconnect the power until the problem has been corrected.

**NOTE: This will reset the filter cycle.**

## **230 VOLTS:**

- A ground terminal is provided on the control box. To reduce the risk of electric shock, connect this terminal to the grounding terminal of your electrical service or subpanel with a continuous green, insulated copper wire. The wire must be equivalent in size to the circuit conductors supplying the equipment. In addition, a bonding terminal (pressure wire connector) is provided on the outside of the control box for bonding to local ground points. To reduce the risk of electric shock, this connector should be bonded with a No. 8 AWG solid copper wire to any metal ladders, water pipes, or other metal within 5 feet (1.5 m) of the spa to comply with local requirements. The means of disconnection must be readily accessible, but must be installed at least 5 feet (1.5 m) from the spa.
- Your spa requires a suitably rated circuit breaker to open all ungrounded supply conductors.
- Your spa must have a ground fault circuit interrupter in an electrical subpanel. Before each use of the spa and with the unit operating, push the TEST button on the breaker. The switch should click over to the "Trip" position. Wait 30 seconds and reset the GFCI breaker by switching it completely off and then completely on. The switch should then stay on. If the interrupter does not perform in this manner, it is an indication of an electrical malfunction and the possibility of an electric shock. Disconnect the power until the fault has been identified and corrected.

**IMPORTANT:** Failure to wait 30 seconds before resetting the GFCI may cause the spa's Power Indicator (on the control panel) to blink. If this occurs, repeat the GFCI test procedure.

## **⚠ DANGER: RISK OF ELECTRICAL SHOCK**

- Install spa at least 5 feet (1.5 m) from all metal surfaces. A spa may be installed within 5 feet (1.5 m) of a metal surface if each metal surface is permanently connected by a minimum No. 10 AWG solid copper conductor attached to the wire ground connector on the terminal box that is provided for this purpose if in accordance with National Electrical Code.
- Do not permit any electrical appliances, such as a light, telephone, radio, or television within 5 feet (1.5 m) of a spa. Failure to maintain a safe distance may result in death or serious personal injury due to electrocution if the appliance should fall into the spa.
- Install your spa in such a way that drainage is away from the electrical compartment and from all electrical components.

### **DO:**

- Be sure your spa is connected to the power supply correctly - use a licensed electrical contractor.
- Disconnect the spa from the power supply before draining the spa or servicing the electrical components.
- Test the Ground Fault Circuit Interrupter before each use.

### **DON'T:**

- Use the spa with the equipment compartment door removed.
- Place electrical appliances within 5 feet (1.5m) of the spa.
- Attempt to open the electrical control box. There are no user serviceable parts inside.



# SAFETY INFORMATION

## RISKS TO AVOID

### **DANGER: RISK OF INJURY**

- DO NOT sit in the filter compartment area. Sitting in this area can cause:  
a) Restriction of Filter Pump suction/ vacuum b) Damage to components
- Both can result in bodily harm. Should damage occur to components in this area, replace immediately!

To reduce the risk of injury to persons, DO NOT remove floating weir, basket, and filter located in the filter compartment while the spa is running.

- The suction fittings in the spa are sized to match the specific water flow created by the pump. Never replace a suction fitting with one rated less than the flow rate marked on the original suction fitting.
- There is a danger of slipping and falling. Remember that wet surfaces can be very slippery. Take care when entering or exiting the spa.
- Never operate spa if the suction fittings are broken or missing.
- The device should not be used by persons (including children) with reduced physical, sensory or mental capabilities, or lack of experience and knowledge, unless they receive supervision or training.
- People with infectious diseases should not use the spa.
- Keep any loose articles of clothing or hanging jewelry away from rotating jets or other moving components.

### **Increased side effects of medication**

- The use of drugs, alcohol or medication before or during spa use may lead to unconsciousness with the possibility of drowning.
- Persons using medications should consult a physician before using a spa; some medication may cause a user to become drowsy, while other medication may affect heart rate, blood pressure, and circulation.
- Persons taking medications which induce drowsiness, such as tranquilizers,

antihistamines or anticoagulants should not use the spa.

### **Health problems affected by spa use**

- Pregnant women should consult a physician before using spa.
- Persons suffering from obesity or with a medical history of heart disease, low or high blood pressure, circulatory system problems, or diabetes should consult a physician before using spa.

### **Unclean water**

- Keep the water clean and sanitized with correct chemical care. The recommended levels for your spa are:  
Free Available Chlorine: 3.0-5.0 ppm  
Total Alkalinity: 40 - 120 ppm  
Water pH: 7.2 - 7.8  
Calcium Hardness: 75 - 150 ppm  
**IMPORTANT:** Turn jet pump on for at least ten minutes after adding ANY spa water chemicals into the filter compartment.
- Clean the filter cartridge monthly to remove debris and mineral buildup which may affect the performance of the hydromassage jets, limit the flow, or trip the high-limit thermostat which will turn off the entire spa.

## **AVOIDING THE RISK OF HYPERTHERMIA**

Prolonged immersion in hot water can result in HYPERTHERMIA, a dangerous condition which occurs when the internal temperature of the body reaches a level above normal 98.6°F (37°C). The symptoms of hyperthermia include unawareness of impending hazard, failure to perceive heat, failure to recognize the need to exit the spa, physical inability to exit the spa, fetal damage in pregnant women, and unconsciousness resulting in a danger of drowning.

### **WARNING:**

The use of alcohol, drugs, or medication can greatly increase the risk of fatal hyperthermia in hot tubs and spas.

# SAFETY INFORMATION

## **TO REDUCE THE RISK OF INJURY:**

- The water in the spa should never exceed 104°F (40°C). Water temperatures between 100°F (38°C) and 104°F (40°C) are considered safe for a healthy adult. Lower water temperatures are recommended for extended use (exceeding 10 minutes) and for young children. Extended use can cause hyperthermia.
- Pregnant or possibly pregnant women should limit spa water temperatures to 100°F (38°C). Failure to do so may result in permanent injury to your baby.
- Do not use spa immediately following strenuous exercise.

## **AVOIDING THE RISK OF SKIN BURNS:**

- To reduce the risk of injury, before entering a spa the user should measure the water temperature with an accurate thermometer.
- Test the water with your hand before entering the spa to be sure it's comfortable.

## **SAFETY SIGN:**

A SAFETY SIGN is included in the owner's package. The sign, which is required as a condition of Product Listing, should be permanently installed where it is visible to the users of the spa.

## **IMPORTANT SPA INSTRUCTIONS**

The following contains important spa information, and we strongly encourage you to read and apply them.

### **DO:**

- Use and lock the vinyl cover when the spa is not in use, whether it is empty or full.
- Follow the Spa Care and Maintenance recommendations stated in this manual.
- Use only approved accessories and recommended spa chemicals and cleaners.

### **DON'T:**

- Leave the spa exposed to the sun without water or the vinyl cover in place. Exposure to direct sunlight can cause solar distress of the shell material.
- Roll or slide the spa on its side. This will damage the siding.
- Lift or drag the cover by using the cover lock straps; always lift or carry the cover by using the handles.
- Attempt to open the electrical control box. There are no user serviceable parts inside. Opening of the control box by the spa owner will void the warranty. If you have an operational problem, carefully go through the steps outlined in the Troubleshooting section. If you are not able to resolve the problem, contact Customer Service (888) 961-7727 Ext. 8440. Many problems can easily be diagnosed over the telephone.

## **PLANNING A LOCATION FOR YOUR SPA**

Consider these things when determining where to place your spa.

### **SAFETY FIRST:**

Make sure your spa is positioned so access to the equipment compartment and side panels will not be blocked. Be certain your installation will meet all city and local safety codes and requirements.

### **PLANNED USE OF SPA:**

How you intend to use your spa will help you determine where you should position the spa. For example, will you use it more for recreational or therapeutic purposes? If your spa is mainly for family recreation, leave plenty of room around it for activity and lawn furniture. If you will use it more for relaxation and therapy, you'll probably want to create privacy around the spa.

### **PRIVACY:**

Think of your surroundings during all seasons to determine your best privacy options. Consider the view of your neighbors when you plan the location of your spa.

### **VIEWS:**

Think about the direction you will be facing when sitting in your spa. Do you have a special landscape you will find enjoyable? Perhaps there is an area that has a soothing breeze during the day or a lovely sunset in the evening.

### **ENVIRONMENT:**

If you live in a climate with a snowy winter and hot summer, a place to change clothes or a house entry near the spa is convenient. A warmer climate may require shade from the hot sun. Consider placement of trees, shrubs, patio cover or perhaps a gazebo structure to provide what you will need. Indoor installations require adequate ventilation. When the spa is in use, considerable

amounts of moisture are produced. This moisture can damage walls and ceiling surfaces over time. Special paint is available to resist moisture damage. Remember that spas periodically require drainage, so plan your environment accordingly.

### **KEEP CLEAN:**

Prevent dirt and foliage from being tracked into your spa by utilizing concrete for paths and access areas. Check the location of spill paths from gutters, trees, and shrubs.

### **SERVICE ACCESS:**

Many people choose to install tile or custom wood around their spas. If you are installing your tub with custom decorative trimming, remember to allow for access to it for service. Should you need service, a technician may need to remove the tub's door panel, or access it from beneath. It is always best to design special installations so the spa can still be moved, or lifted from the ground.

### **A GOOD FOUNDATION:**

Your new spa needs a good solid foundation. The area your spa sits on must be able to support the spa, the water in it and those who use it. If the foundation is inadequate, it may shift or settle after the spa is in place, causing stress to the shell or components. **NOTE:** Do not shim your spa in any manner, as this could cause the cabinet to crack, thereby voiding the warranty.

### **BE AWARE:**

Damage caused by inadequate or improper foundation support is not covered by the spa warranty. It is the sole responsibility of the spa owner to provide a proper foundation for the spa.

Make sure the foundation where the spa is placed drains water away from the spa. Proper drainage will keep components dry from rain and wet weather.

Your spa weight must always be considered when installing your spa. If you are installing



# INSTALLATION

it on an elevated wood deck or other structure, it is advisable to consult a structural engineer or contractor to ensure the structure will support the weight.

## **IT IS STRONGLY RECOMMENDED THAT A QUALIFIED, LICENSED CONTRACTOR PREPARE THE FOUNDATION FOR YOUR SPA.**

A reinforced concrete pad at least four inches thick is recommended for your spa. The reinforcing rod or mesh in the pad should be attached to a bond wire.

## **INDOOR INSTALLATION:**

Be aware of some special requirements if you place your spa indoors. Water will accumulate around the spa, so flooring materials must provide a good grip when wet. Proper drainage is essential to prevent a build-up of water around the spa. When building a new room for the spa, it is recommended that a floor drain be installed. The humidity will naturally increase with the spa installed. Water may get into woodwork and produce dry rot, mildew, or other problems. Check for airborne moisture's effects on exposed wood, paper, etc. in the room. To minimize these effects, it is best to provide plenty of ventilation to the spa area. An architect can help to determine if more ventilation must be installed.

## **PLACING THE SPA**

### **CHECK THE DIMENSIONS OF YOUR SPA:**

Compare the spa dimensions to the width of gates, sidewalks, and doorways along the delivery route used to bring the spa into your yard. It may be necessary for you to remove a gate or partially remove a fence in order to provide an unobstructed passageway to the installation location. Also, keep in mind—if you are using special equipment to place your spa into an area it will be necessary to include those measurements and weights.

### **PLANNING A DELIVERY ROUTE:**

Check the width of gates, doors and sidewalks to make sure your spa will pass through unobstructed. You may have to remove a gate or part of a fence to allow for adequate width clearance. If the delivery route will require a 90-degree turn, check the measurements at the turn to ensure the spa will fit. Check for protruding gas meters, water meters, A/C units, etc., on your home which will cause obstructions along the delivery path to your yard. Check for low roof eaves, over hanging branches or rain gutters that could be an obstruction to overhead clearances.

### **SPECIAL CIRCUMSTANCES:**

The use of a crane for delivery and installation is primarily to avoid injury to your spa, your property or to delivery personnel. Cranes are not considered “normal delivery”.

# EQUIPMENT ACCESS

## EQUIPMENT ACCESS PANEL

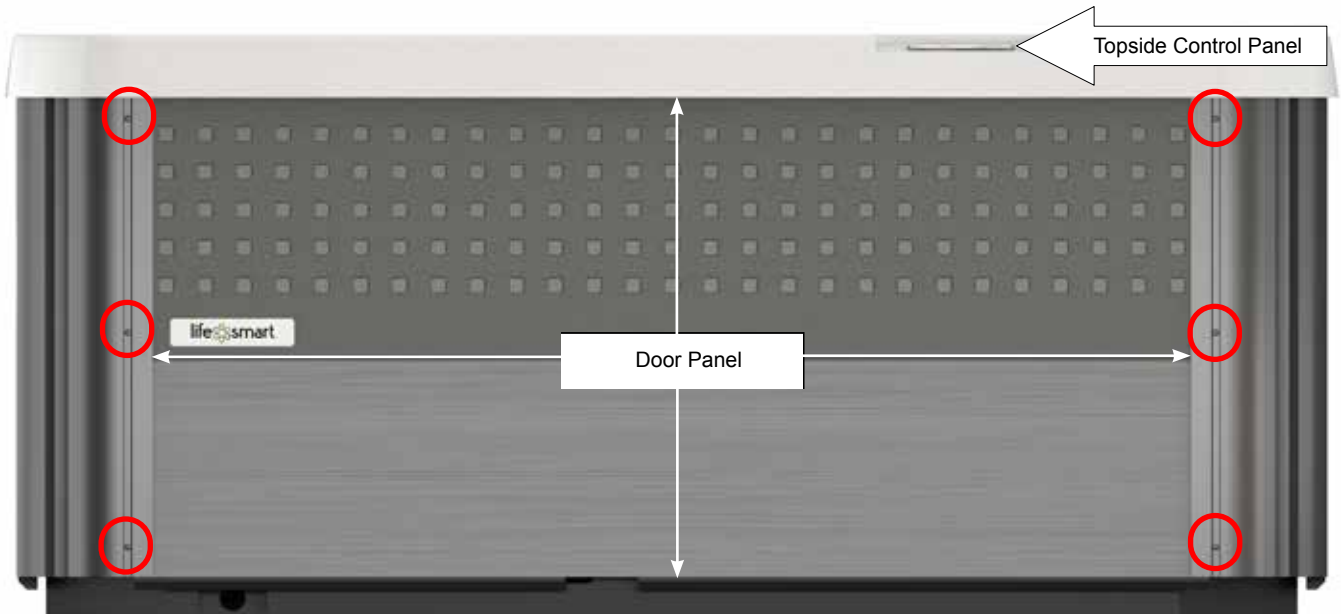

To access the equipment compartment:

Remove the 3 screws (circled above) on each side near corner holding Z part and remove Z part. Raise door panel slightly from bottom center, pull bottom of door away from spa then lower and remove.

Reverse order to attach door panel.

**1 Pump Models**  
Willow, Acacia L & Acacia NL

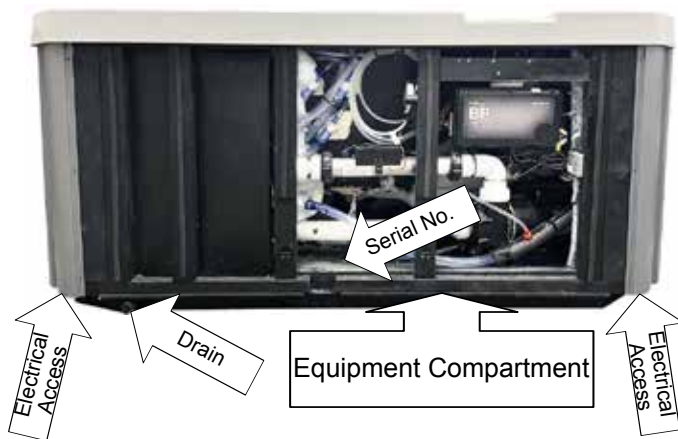

**2 Pump Models**  
Palmetto L & Palmetto NL

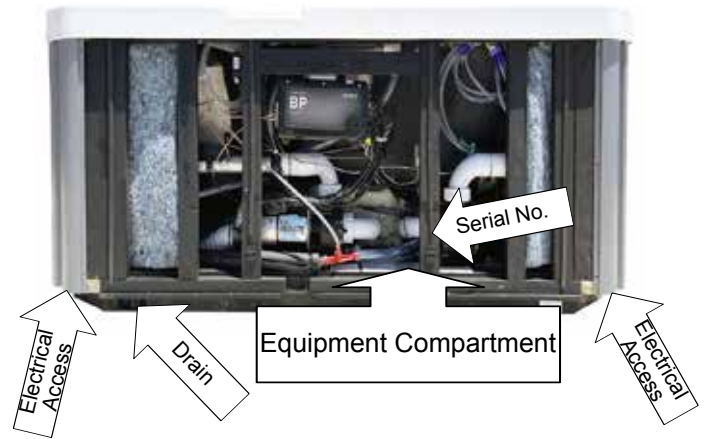

# ELECTRICAL REQUIREMENTS

## ELECTRICAL REQUIREMENT

**⚠ DO NOT POWER THE SPA WITHOUT FIRST FILLING WITH WATER!**

**⚠ DANGER – RISK OF ELECTRIC SHOCK**

Installations that do not conform to the following procedures and requirements may expose users to electric shock. Non-conforming installations will not be covered under warranty.

If installed in the United States, the electrical wiring of this spa must meet the requirements of the National Electric Code (NEC) and any applicable state or local codes. The electrical circuit must be installed by an electrical contractor and approved by a local building electrical inspection authority.

1. Installations within 5 feet (1.5 m) of any metal surfaces must ground the metal surfaces to the hot tub. Use an 8 AWG solid copper wire and attach it to the grounding lug on the control box, located in the equipment compartment.
2. Only a licensed electrician may install power to the spa.
3. Power supply installation must include a suitably rated ground fault circuit interrupter (GFCI) as required by NEC. The circuit breaker must be dedicated and should not be shared with any other appliances. It must be labelled and easily accessible to users.
4. The electrical supply for the spa must include a suitable rated switch or circuit breaker to open all ungrounded supply conductors to comply with the National Electric Code. The disconnecting means must be readily accessible to the spa's occupant but installed at least 5 feet (1.5 m) from the spa water.
5. 230V Power supply lines must be hard wired into the control box. DO NOT use extension or plug-type cords of any kind. The use of a shut-off box near the hot tub is also recommended. This box provides a quick and convenient method to shut off

power to the hot tub for emergencies and maintenance.

6. Supply lines must be properly sized as per the NEC. A ground line must be provided that is as large as the largest current carrying conductor, but no less than 8 AWG. Use copper wiring only.
7. Please open the front cover of the control box, and follow the instructions and wiring diagram printed on the backside.
8. All 115 V powered models must use the provided 15 foot (4.5 m) GFCI cord and be plugged directly into a dedicated grounded wall outlet between 6' (1.8 m) and 10' (3 m) from the spa.
9. CAUTION, 230V POWERED SPA – This spa must be hard wired to your household electrical service box only. Do not use an extension cord or any other disconnectable power cord. The use of an extension cord or a disconnectable power cord is highly dangerous and will void all warranties!
  - Wire size must be appropriate per NEC and/or local codes.
  - Wire size is determined by length of run from breaker box to spa and maximum current draw.
  - THHN copper core wire is recommended.All wiring must be copper to ensure adequate connections. Do not use aluminum wire.

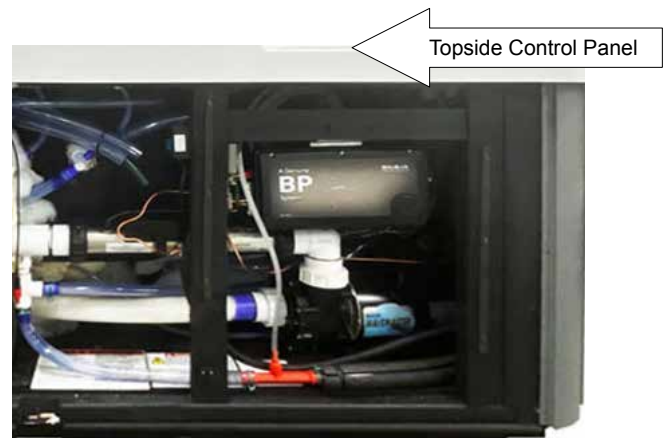

Equipment access is below the topside control panel.

# ELECTRICAL REQUIREMENTS

## CONFIGURING SYSTEM

### SELECTING THE VOLTAGE FOR YOUR WILLOW SPA ONLY

Your Willow/LSA-510L spa is designed to operate at either 115V 15 amp, or a 230V 50 amp circuit.

- When the spa is setup for 115V, the heater will provide approximately 1000 watts of heat only when the pump is operating on LOW speed and the thermostat is calling for heat (NOTE: The heater does not operate when the pump is on high speed).
- When the spa is connected to 230 volts, the heater will provide approximately 4000 watts of heat when the pump is operating in LOW or HIGH speed and the thermostat is calling for heat.

All electrical connections must be made in accordance with the wiring information contained on the electrical control box cover and the NEC.

### 115 VOLT (CORD CONNECTED)

Spas come with a factory-installed GFCI cord and are to be plugged into a grounded type 115 volt, 15 amp receptacle which must be no closer than 6'/1.8m and no further than 10'/3m. No other electrical appliance or fixture can be used on this circuit.

**IMPORTANT:** Under **NO** circumstances should an extension cord be used. Use of an extension cord will seriously degrade the performance of the equipment and can create an electrical hazard.

### 230 VOLT 50 AMP (CONVERSION)

A 115V to 230V conversion requires the following steps:

**NOTE:** A 50 amp GFCI Subpanel is not included.

This installation requires a licensed electrician to complete the following work (use Illustrations below).

- Unpark J31.
- Remove the two Jumpers found on J24. Using one of the jumpers connect the middle two pins.
- Replace F3 Fuse 1.6 with the fuse found attached to the back of the control box .1.
- Move Dip Switch 2 to ON for Heater to go on when the two speed pump is on and system is calling for heat.
- Move Jet Pump 1 White wire from J32 to J4
- Move White neutral wire from J88 and attach to J8.
- Remove the GFCI cord wires attached to the terminal block.



115 Volt Connected

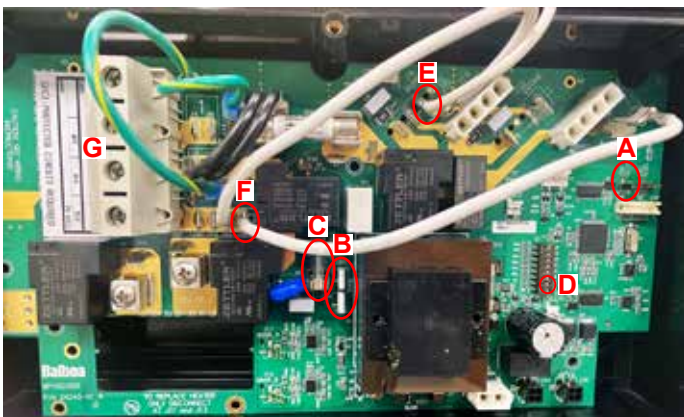

230 Volt Connected (Conversion)

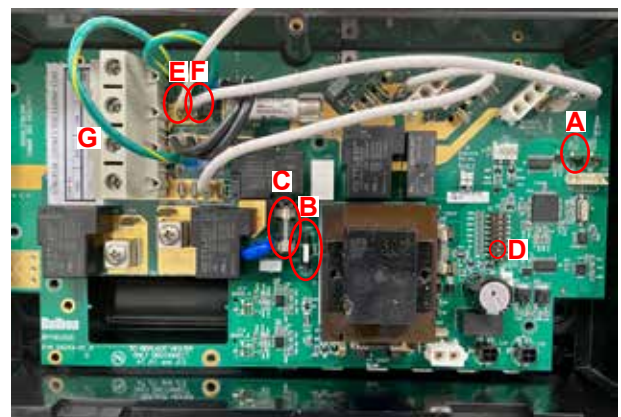



# ELECTRICAL REQUIREMENTS

## ELECTRICAL WIRING DIAGRAM 230V USE

It is recommended that a licensed electrician install the power to your spa in accordance with the National Electric Code and/or any local electrical codes in effect at the time of installation.

Power supply installation must include a properly rated GFCI circuit breaker. The circuit must be dedicated and should not be shared with any other appliances. The power supply must be hard wired into the power pack.

### 230V Wiring Instructions:

4 wires/50 amp GFCI Breaker #8 AWG 75°C Copper Wire Minimum (less than 100' (30 m) length)

### Special Note:

If the GFCI breaker trips immediately after attempting to turn on, please check the White Neutral Wire that is connected to the spa.

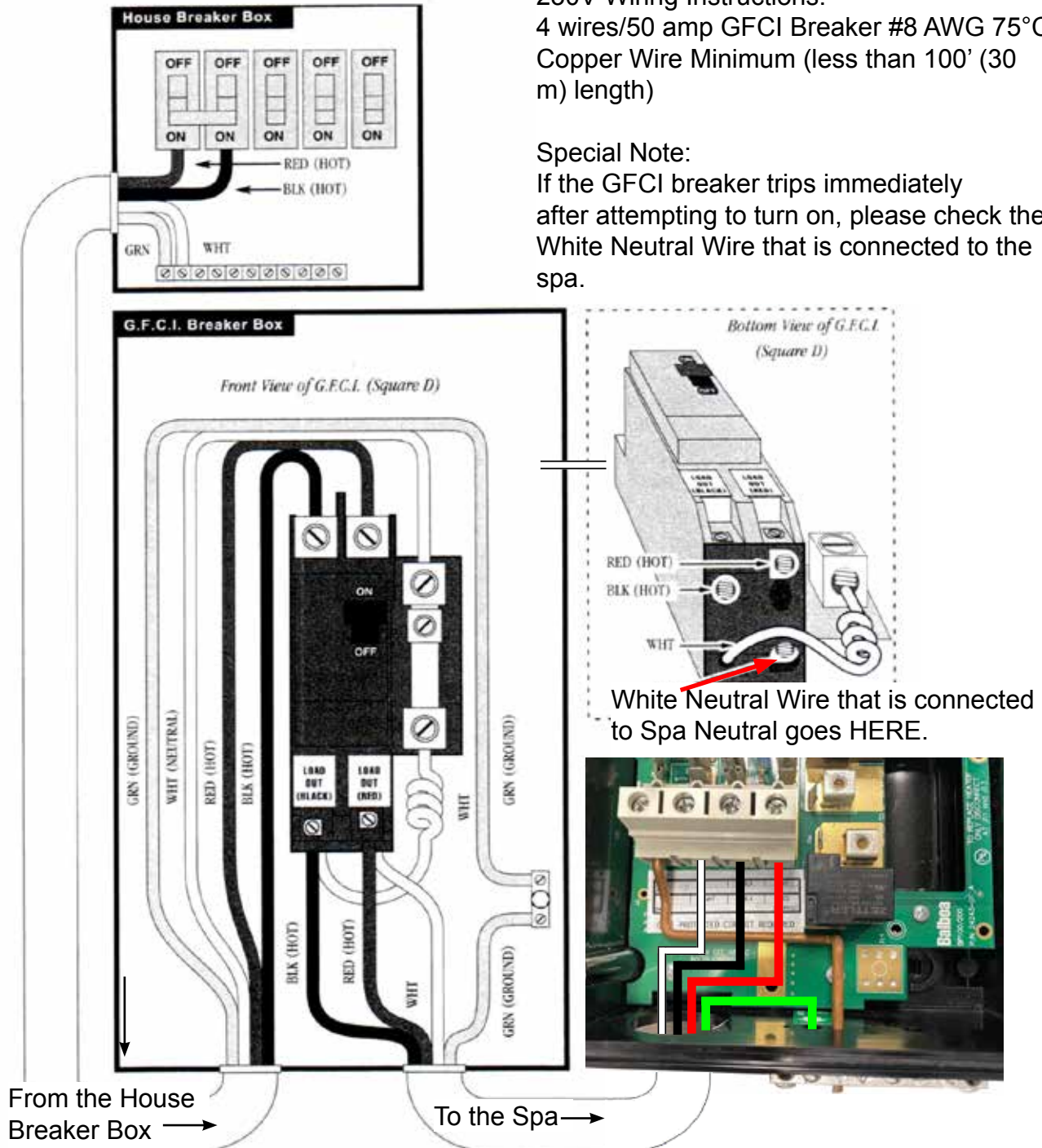



# CONTROL PANEL OPERATION

**INITIAL START-UP** - When the spa is first powered up the spa panel display (view right) will go through a specific sequence. This sequence is normal and will display a variety of information regarding the configuration of the control system. After the sequence ends, the control system will start Priming Mode which will last for 4-5 minutes.

During Priming Mode this panel message (view right) indicates that the spa is in Priming Mode, the heater is disabled to allow the priming process to be completed without the possibility of energizing the heater under low-water-flow or no-water-flow conditions.



When Priming Mode ends the panel will display dashes. Once the control system cycles water through the heater for one minute, the dashes will be replaced by the water temperature.

Your spa has been designed so that it will automatically heat the water to the factory set temperature of 100°F (38°C) unless you set the spa to a different temperature. If power is disconnected from the spa, it will automatically revert back to the last saved set temperature when power is reapplied.

**NOTE:** The Palmetto L (LSA-720L) & Palmetto NL (LSA-720) have two pumps using the 2 pump Control Panel.

## JETS OPERATION

### Jet Pump 1 button:

- Press Jets 1 button once to turn Jet Pump 1 on low speed.
- Press Jets 1 button a second time to turn Jet pump1 on high speed.
- Press Jets 1 button a third time to shut Jet Pump1 off.

I Pump Control Panel



Spa Panel Display



2 Pump Control Panel

**NOTE:** When the low-speed turns on automatically due to spa temperature detection (polling) and then to heat to the set temperature if needed, it cannot be turned off from the panel, however the high speed may be started.

### Jet Pump 2 button:

(Available on Palmetto L LSA-720L & Palmetto NL LSA-720 models only)

- Press Jets 2 button once to turn Jet Pump 2 On.
- Press Jets 2 button a second time to shut Jet Pump 2 Off.

## MULTI COLOR LED LIGHT

Press the *Light* button once to turn on the lights, press the button again to turn the lights off, when turning back on after several seconds the same light mode will appear. Every time the light is quickly turned off and on a new light mode will appear. The sequence is as follows: White, Aqua, Magenta, Azure, Amber, Emerald, Ruby, Color wheel with abrupt color changes, Slow full color wheel and Fast full color wheel.

**NOTE:** If left on, the light will automatically turn off after 4 hours of operation.

# CONTROL PANEL OPERATION

## TEMP ADJUSTMENTS

The current water temperature will constantly display on LCD.

Press the Warm/Temp  $\wedge$  or Cool/Temp  $\vee$  buttons to display the set temperature (desired temperature). Each time either button is pressed again, the set temperature will increase or decrease depending on which button is pressed.

After five seconds, the LCD will automatically display the current spa temperature.



## TEMPERATURE RANGE

The temperature can function between 80°F - 104°F (26.6°C - 40°C) High Range (TR:HI) or 50°F - 99°F (10°C - 37.2°C) Low Range (TR:LO).

To change the Temperature Range between Hi and Low do the following:

- Press the TEMP button.
- While set TEMP is Flashing, press LIGHT button until TR:HI or TR:LO appears. The first one to appear is the current range.
- To change, press the TEMP button followed by the LIGHT button to save new setting.

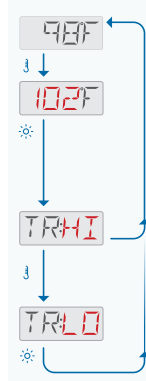

**IMPORTANT: IF YOUR SPA SET RANGE WILL NOT GO HIGHER THAN 99°F (37.2°C) YOU ARE IN THE TR:LO MODE! CHANGE TO TR:HI MODE FOR A HIGHER TEMPERATURE**

## HEAT MODES

There are two heat modes you can select from, the Ready Mode (RDY) and Rest Mode (REST).

- Ready Mode keeps the water temperature close to the Set Temperature 24 hours a day. Use this mode for everyday usage.
- Rest Mode only heats water during filter cycles. Use this mode if spa is not used for extended periods of time.

To change the Heat Modes do the following:

- Press the TEMP button.
- While set TEMP is Flashing, press LIGHT button two times until RDY or REST appears. The first one to appear is the current Heat Mode.
- To change to the other mode press the TEMP button followed by the LIGHT button.

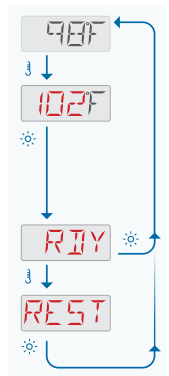

When in the Rest Mode the main screen will alternate between water temperature and REST.



**NOTE:** A third mode will activate and display (RRST) whenever the JETS button is pressed while in the REST mode this is called Ready-in-Rest mode and will run for 1 hour. This subfeature mode will turn the heater on and attempt to keep the water temperature close to the set temperature. The main screen will alternate between water temperature and RRST for the hour.



### SEQUENCE KEY

- Flashing characters
- Progressive message
- ↓ Press TEMP button for "action"
- ☀ Press LIGHT button to "select"
- Pause / back to Main Screen / setting not saved
- Pause / back to Main Screen / setting saved
- ▭ Menu Items may or may not appear

# CONTROL PANEL OPERATION

## FILTER CYCLES

There are two filter cycles: the first cycle (F1) starts after spa is powered up (if the Time-of-Day) is Not set. A second cycle (F2) is OFF by default. The default duration for the first filter cycle is 1.5 hours. Filter cycles are set using a start time and a duration. Hours are adjusted in 1-hour increments, and minutes are adjusted in 15-minute increments. The end time is calculated and displayed automatically.

## SET TIME-OF-DAY

Setting the Time-of-Day is important for determining water filtration times.

**NOTE:** If Time-of-Day has not yet been set, SET TIME will flash on the display in the TIME menu.

To set or change the Time-Of-Day do the following:

- Press the TEMP button.
- While set TEMP is Flashing, press LIGHT button three times until SET TIME or TIME appears.
- Press TEMP, and the hour will flash, continue pressing TEMP to change to the current hour.
- Press LIGHT to select the minutes, press TEMP to change the minutes to the current time.
- Press LIGHT to save your settings.



**NOTE:** The system does NOT keep track of Time-of-Day when powered down and clock will revert back to 12:00PM when powered is back up.

### SEQUENCE KEY

- Flashing characters
- Progressive message
- ↓ Press TEMP button for "action"
- ☀ Press LIGHT button to "select"
- Pause / back to Main Screen / setting not saved
- Pause / back to Main Screen / setting saved
- ▭ Menu Items may or may not appear

## SET FILTER CYCLES

To program the cycle times:

1. Press the TEMP button.
2. While set TEMP is Flashing, press LIGHT button several times until F1 appears.
3. Press TEMP to view BEGN F1 message.
4. Press TEMP again to view current start time.
5. Press TEMP button a third time to change the starting hour. Continue pressing TEMP until the desired hour is reached.
6. Press LIGHT to switch from hour to minutes.
7. Press TEMP to change the minutes.
8. Press LIGHT to save the F1 filter start time.
9. Press TEMP as many times as necessary to view and change the duration of the filter cycle hours.
10. Press LIGHT to switch to duration minutes. Use TEMP to change minutes duration.
11. Press LIGHT to save the duration time. After duration is saved a message will display showing the time when your filter cycle will end.



**NOTE:** Should you choose to run a second filter cycle (F2) repeat the previous process except press the TEMP button an extra time in step 2 allowing (F2) to appear.

# CONTROL PANEL OPERATION

## RESTRICTING OPERATION TEMPERATURE LOCK/UNLOCK

Locking the Temperature allows Jets and other features to be used, but the Set Temperature and other programmed settings cannot be adjusted.

Temperature Lock allows access to a reduced selection of menu items.

To program the Temp Lock:

- Press the TEMP button.
- While set TEMP is Flashing, press LIGHT button several times until LOCK appears.
- Press TEMP button and TEMP will appear, press the TEMP button a second time and OFF will appear. By pressing TEMP a third time the ON will appear.
- Press LIGHT button to lock the temperature and settings.

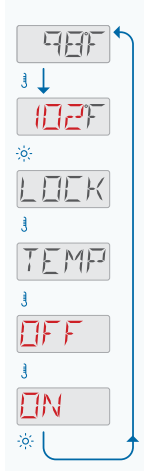

To unlock the temperature LOCK feature do the following:

- Press the TEMP button.
- While set TEMP is Flashing, hold down the TEMP button, then press the LIGHT button two times slowly. UNLK indicates that it has been unlocked.
- Press the LIGHT button and the Main Screen will appear, or by pausing a moment it will automatically go back to the Main Screen.

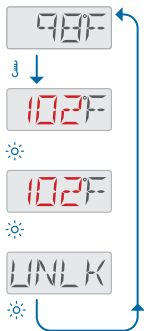

## CONTROL PANEL LOCK/UNLOCK

Locking the panel Prevents the panel and its functions from being used. All automatic functions are still active.

To program the Panel Lock:

- Press the TEMP button.
- While set TEMP is Flashing, press LIGHT button several times until LOCK appears.
- Press TEMP button and TEMP will appear
- Press LIGHT button and PANL will appear.
- Press TEMP button two times for the ON to appear.
- Press LIGHT button to set Lock.

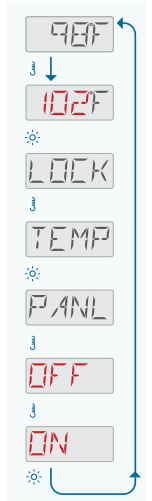

To unlock the temperature LOCK feature do the following:

- Press the TEMP button. LOCK will appear.
- While holding down the TEMP button press the LIGHT button two times slowly. UNLK indicates that it has been unlocked.
- Press the LIGHT button and the Main Screen will appear, or by pausing a moment it will automatically go back to the Main Screen.



## OTHER FUNCTIONS

### SEQUENCE KEY

- Flashing characters
- Progressive message
- ↓ Press TEMP button for "action"
- ☀ Press LIGHT button to "select"
- Pause / back to Main Screen / setting not saved
- Pause / back to Main Screen / setting saved
- ▭ Menu Items may or may not appear

# CONTROL PANEL OPERATION

## INVERT DISPLAY

Follow this sequence to invert the display.

- Press the TEMP button.
- While set TEMP is Flashing, press LIGHT button several times until FLIP appears.
- Press the TEMP button to flip the display.
- Press the LIGHT button to save this setting.



## HOLD MODE

Hold Mode is used to disable the pumps during service functions like cleaning or replacing the filter. This mode will last for 1 hour unless it is exited manually by pressing the LIGHT button.

Follow this sequence to invert the display.

- Press the TEMP button.
- While set TEMP is Flashing, press LIGHT button several times until HOLD appears.
- Press the TEMP button to place the pump(s) on Hold for on hour.
- HOLDING FOR 1:00 Message will appear for the entire hour
- You can exit Hold at any time by pressing the LIGHT button. DONE will appear after a moment before going back to water temperature.

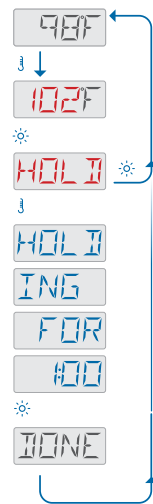

## PREFERENCES MENU

The PREF menu allows some other options such as:

- F or C for your temperature setting.
- Having 24 hour clock (military time) or 12 hour clock (am/pm).
- Turning On or Off any reminders that may show up.
- Setting the amount of time for a Clean-Up cycle if the default of 30 minutes needs to be changed.

Follow this sequence to use PREF menu.

- Press the TEMP button.
- While set TEMP is Flashing, press LIGHT button several times until PREF appears.
- Press the TEMP button to enter the PREF mode
- Press the Light to scroll to the desire function then press TEMP to access and modify the function.

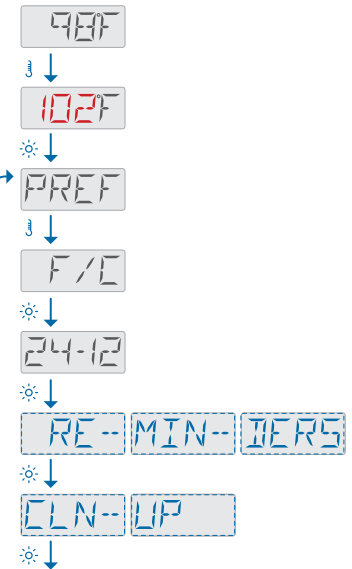

**For more detailed information of your control system an Owner's Manual Supplement is available online. Go to:**

[https://cdn.shopify.com/s/files/1/0449/3839/5807/files/304573.24SUP\\_Rev\\_A\\_DPS\\_Lifesmart.pdf?v=1689980209](https://cdn.shopify.com/s/files/1/0449/3839/5807/files/304573.24SUP_Rev_A_DPS_Lifesmart.pdf?v=1689980209)

Or scan the QR code below:





## **SPA COMPONENT OPERATION**

### **AIR CONTROL VALVE**

The air control valves (smaller valves) serve to regulate the amount of air mixed with the water when the jets are operational. Turn the air control valves in one direction to increased jet action. Rotating the air control in the opposite direction to turn air off and allow the jets to work with water only. Turn the air controls off when the spa is not in use, this will prevent cold air from entering the spa and will keep heating cost to a minimum. The ozone jet, will always produce air bubbles when pump is on.

### **DIVERTER VALVE**

**(Willow/LSA-510L model only)**

The diverter valves (larger valves) on your spa allows you to direct the flow of water to one of the jet flow combinations. Your spa has two pumps and two diverter valve, each diverter valve works with one pump. The function of the diverter valves can best be learned by experimentation. Turn the large valve completely to one side to see which jets are on, then turn completely to the other to see which jets are affected if nothing seems to happen than try the other diverter valve. (You can adjust the diverter value to any position between the two possible extremes to achieve the jet pressure that feels best to you.)

**IMPORTANT:** Your spa is not designed to provide full power to all jets when the diverter valves are in the “mid” position. However with the diverter valve in this position, you may increase the power to selected jets by rotating the faces of the hydrotherapy jets to close the ones that are not in use.

### **HYDROTHERAPY JETS**

The hydrotherapy jets are recessed in the wall of the spa. Rotate the large or medium jet faces to turn the jets on or off. Turning a jet on or off will increase or decrease the effects of any jets not in the closed position.

### **OZONE GENERATOR**

The ozone system enhances the quality of the spa water when used to supplement the spa owner’s regular water maintenance program. Contrary to some information circulated throughout the pool and spa industry regarding ozone systems, ozone **CAN'T** be used as a single-source sanitizer, water clarifier, anti-foamer, and mineral chelating agent. A secondary source sanitizer must be used to maintain 3.0 - 5.0 ppm of Free Available Chlorine (FAC). **LIFESMART** recommends that a chemical maintenance program based on recognized and documented industry standards still be followed when using an ozone purification system to assure water sanitation and the highest quality purified water.

### **WATERFALL**

**(When Equipped)**

Your spa has a control valve to operate the amount of flow through the waterfall from no flow to a steady stream. This valve is near the waterfall. The waterfall will only work when Jet Pump 1 is on. Rotate the valve to turn on or off.

## FILL-UP AND START-UP INSTRUCTIONS

The following procedures should be followed on initial startup and whenever the spa is drained for routine maintenance.

### **FILLING THE SPA WITH WATER**

1. Clear all the debris from your spa.
2. Be sure to open all jets to allow as much air as possible to escape from the plumbing during the filling process.
3. **Insert a garden hose into filter compartment to fill your spa.**

**NOTE:** Do not use hot or softened water.

4. As the water level rises, check inside the equipment compartment for water leaks. It may be necessary to tighten unions

EQUIPMENT COMPARTMENT

UNIONS

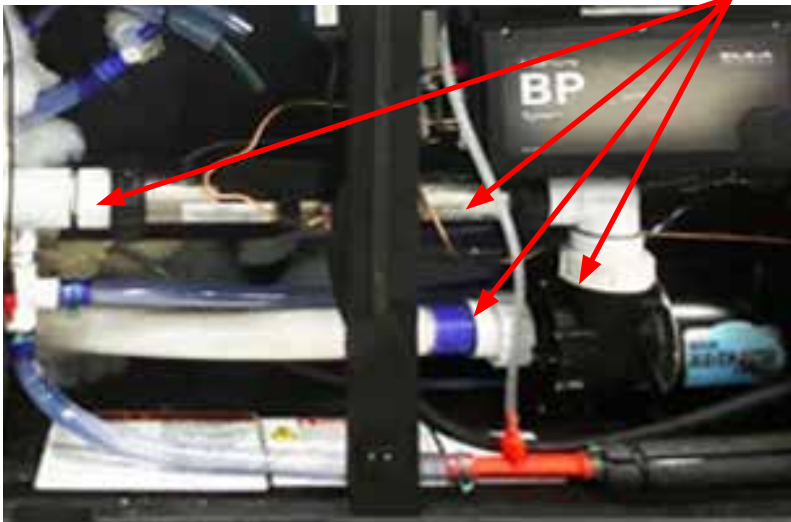

and/or fittings that may have loosened during delivery. There is no need to call for service; this can easily be done. If assistance is required, contact a Customer Service representative at (888) 961-7727 Ext. 8440.

5. Under normal circumstances keep the water level half way between the top of the spa and the top of the filter ring or just above the highest jets (whichever is higher).

Failure to keep enough water in your spa may result in damage to your system and invalidate your warranty. If your spa filter is sucking in air causing the pump to cavitate, you need to add water!

6. Check the filter installation and make sure the filter is not loose.

### **APPLYING POWER**

1. Turn power to spa "ON" (after filling spa) from the main panel at the house and the subpanel.
2. Press *Jets* button on the topside control panel to activate the spa. Rotate all the air control valves clockwise and observe the increased jet action (air mixed with water). After several minutes.

3. While the pump is running check again for water leaks at the drain spigot, unions, or fittings in the equipment compartment (leaks may have occurred during transit). If water is leaking from one of these areas, there is no need to call for service. Simply tighten the fitting. If assistance is required, call a Customer Service representative at (888) 961-7727 Ext. 8440.

4. After checking your spa for leaks it is now time to adjust your spa settings. Press the *Plus* or *Minus* button on your topside control panel until the display indicates your desired temperature is set, after 5 seconds of non activity the control panel will display the actual water temperature.

## **WATER CHEMISTRY GUIDELINES**

Spa water chemistry is ultimately the responsibility of the spa owner. Improper water chemistry may result in costly repairs not covered under the spa warranty. If unsure about any step in the process, please contact a Customer Care Associate at (888) 961-7727 Ext. 8440 or at [ahsservice@watkinsmfg.com](mailto:ahsservice@watkinsmfg.com).

Initially, it is advisable to identify what minerals (e.g. iron) are present in the local source water. This will provide a better understanding of how to treat the water. Please follow the four steps below and be sure to achieve the correct levels in each area before moving onto the next step.

### **STEP #1: ESTABLISH PROPER PH LEVEL:**

The recommended range for pH is between 7.2 and 7.8. Above 7.8, the water is too alkaline and can result in cloudy water, and scale formation on the shell and heater. To lower the pH use a pH Down/Decreaser (sodium bisulfate). Below 7.0 (considered neutral), the spa water is too acidic and can damage the heating system. To increase pH, use a pH Up/Incraser (sodium hydrogen carbonate). Any pH Up or Down should be added one teaspoon at a time, waiting one-half hour between application and re-measuring.

### **STEP #2: MEASURE TOTAL ALKALINITY:**

The Total Alkalinity is the amount of bicarbonates, carbonates, and hydroxides present in the spa water. Proper total alkalinity is important for pH control. If the TA is too high, the pH is difficult to adjust. If the TA is too low, the pH will be difficult to hold at the proper level. The ideal range is between 40-120 parts per million (ppm). Reduce TA by using an Alkalinity Down/Decreaser (sodium bisulfate). Increased TA by adding an Alkalinity Up/Incraser (sodium bicarbonate or sodium hydrogen carbonate).

These products should be added in small amounts - 5 ml at a time. After adding 5 ml, wait one half hour before re-measuring. Once the safe range of total alkalinity is established, proceed to the next step.

### **STEP #3: DETERMINE CALCIUM HARDNESS:**

It is important to bring the calcium reading to between 75-150 ppm. If the reading requires adjustment, it should now be corrected. If the water is too soft (a low reading) calcium hardness should be added to the water to increase the ppm reading. If the water is too hard (a high reading), it can be corrected by either: (A) a mixture of hard and soft water added to attain a reading in the safe range, or (B) addition of stain and scale control. If calcium hardness is a problem with the local source water (either too hard or too soft) a test kit, which measures calcium hardness, is essential.

### **STEP #4: SANITIZING:**

After steps 1-3 are complete, **the spa must be sanitized using Chlorine (sodium dichlor)**. Add 2 teaspoons of Chlorine, and increase as necessary to reach a level of 3-5 ppm. Check and maintain this level weekly, and before and after using the spa. ***IMPORTANT NOTE:*** *A granulated sodium dichlor is highly recommended for sanitizing spa water, granular bromine may also be used. Never use compressed sanitizers even with a floater. As with any other chemicals, the sanitizer should be introduced to the spa with the jets running for 10 minutes.*

### **WEEKLY SHOCK:**

Using a potassium monopersulfate (MPS) shock, add approximately 2 oz. (60 ml) spreading it over the water while the jets are running. Shocking is achieved by adding the MPS to turbulent water. Leave the cover up and jets on high for 10 minutes. Then shut jets off and return the cover to the closed position to maintain heat.

## FILTER CARTRIDGE MAINTENANCE

At least once a week, check and clean the skimmer basket and weir to ensure proper filter flow. Remove leaves, foreign matter, and debris. It is very important to keep your spa filter cartridge clean and free of particles to ensure proper water flow. A clean filter permits the hydrotherapy system to function properly and also allows more efficient filter cycles. Depending on how frequently your spa is used, we recommend cleaning the spa filter cartridge every four weeks. If this is not done, the filter may clog and restrict water flow, which causes improper filtration and poor jet performance.

**IMPORTANT:** The frequency and duration of use, and the number of occupants all contribute to determining the appropriate time between filter cleanings. More use means that more frequent filter cleanings will be required.

### FILTER CARTRIDGE REMOVAL AND CLEANING INSTRUCTIONS

1. Go to HOLD mode (see pg. 15)
2. Using two tabs (Figure 1a) rotate 45° counter clockwise until basket stops (Figure 1b).
3. Pull floating weir and basket from spa (Figure 2)
4. Remove the filter cartridge (Figure 3) using the handle and pull out of the spa.
5. Always clean the filter using a filter degreaser to remove mineral and oil build-up. Soak the filter in the degreaser (according to the package directions). Then place the filter on a clean surface and, using a garden hose, spray until it is clean. It may be necessary to rotate the filter while spraying to remove any debris lodged between the filter pleats.
6. Replace the cartridge in the spa. Lower the basket and weir over filter cartridge and rotate basket clockwise until it stops.
7. Remove HOLD by pressing LIGHT button.

**CAUTION!** Always use proper eye protection when using chemicals, or high-pressure water. Read instructions on cleaning products and follow applicable safety and warning instructions listed on label.

**CAUTION!** Never scrub the filter cartridge with a brush, as this will cause the filter to wear out and come apart. Never let the spa pump run without a filter cartridge in the skimmer compartment. Running the spa without a filter cartridge may permit debris to enter the spa plumbing and void the warranty!

Figure 1a



Figure 1b



Figure 2



Figure 3

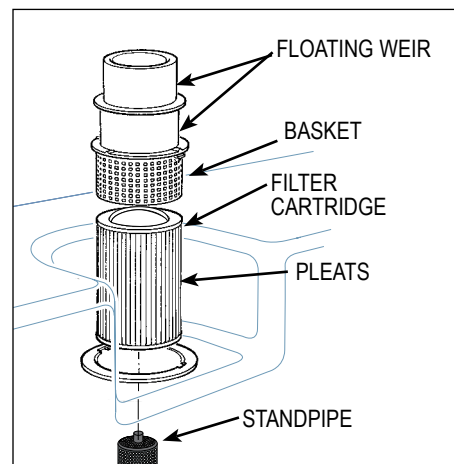

## SPA MAINTENANCE

### ***SURFACE CARE***

Do not use solvents or abrasive cleaners to clean the spa. Typically, a mild detergent and water will resolve cleaning issues.

### ***COVER CARE***

The cover is made with a solution dyed polyester fabric and is an attractive, durable foam insulation product. Monthly cleaning is recommended to maintain its beauty and a longer fabric life.

To clean and condition the polyester cover:

1. Remove and gently lean against a wall or fence. If a cover lifter has been installed keep cover closed and make sure all seams are closed to prevent any soap from entering the spa.
2. With a garden hose, spray the covers to loosen and rinse away dirt or debris.
3. Add four tablespoons of mild soap or mild dishwashing liquid with one gallons (4 liters) of lukewarm water. Clean using a soft bristle brush. Rinse thoroughly with cold water and air dry.  
**IMPORTANT:** Do not let the polyester dry with a soap film on it before it can be rinsed clean.
4. Scrub the cover's perimeter and side flaps. Rinse clean with cold water.
5. Rinse off the underside of the cover with water only (use no soap), and wipe it clean with a dry rag.

### ***CABINET CARE***

Little maintenance is required to keep your spa cabinet looking good.

Spa cabinet product should be cleaned as needed to remove dirt and debris.

- NO abrasive or harsh chemicals should be used on the spa's cabinet.
- NO solvents or cleaners containing aromatic solvents should be used on the spas cabinet.
- Hot soapy water is the best choice for cleaning the spa's cabinet.

### ***SPA LED LIGHT REPLACEMENT***

Should you have any LED points of light issues, please contact a service technician.



## DRAINING OR WINTERIZING

Every three to six months, depending upon the water condition, you need to renew your water.

**CAUTION:** READ THIS BEFORE DRAINING YOUR SPA

- To prevent damage to the spa's components, **TURN OFF SUBPANEL BREAKER BEFORE DRAINING. Do not power back up until your spa has been refilled with water.**
- There are certain precautions to keep in mind when draining your spa. If it is extremely cold, and the spa is outdoors, freezing could occur in the plumbing or the equipment.
- Do not leave the spa's shell (inside surface) exposed to direct sunlight.

### DRAINING YOUR SPA

- a. Route the outlet of the drain hose to an appropriate draining area. Locate the drain (bottom front) of the spa, remove the drain cap and attach the inlet of a garden hose to drain the spa, (to avoid flooding of the foundation surrounding the spa).

**NOTE:** Spa water with a high sanitizer level may harm plants and grass.

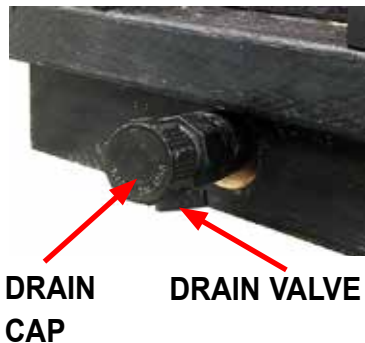

- b. Open the drain valve by turning the knob to allow the water to drain from spa.
- c. After your spa is empty, clean the shell and filter cartridge. See "Spa Maintenance" section.
- d. After cleaning, close drain valve and reinstall the drain cap.
- e. Follow the "Fill up and Applying Power" instructions on page 17.

### WINTERIZING YOUR SPA

If you plan to store your spa for the winter, you must also use a wet-vac to clean out the water lines to ensure they are free of any

water. Water left in the lines might freeze and damage the lines and jets.

- a. It will be necessary to remove all water from the interior plumbing.
- b. Remove the floating weir, basket, and filter cartridge. Clean the filter cartridge and store in a dry place. Attach the vacuum hose to the **vacuum side** of the shop vac and thoroughly dry the filter compartment.
- c. Using the shop vac, remove the water starting with the jets at the top and moving to the ones at the bottom of the spa. **NOTE:** When removing the water from jet openings, you may notice suction coming from another jet. With the help of a second person, block off any suction from the other jet using a large rag or cloth. This will help pull out the water that is trapped deep inside the main line.
- d. Thoroughly dry the spa shell with a clean towel.
- e. Using a funnel, pour Propylene glycol anti-freeze into the filter suction fittings and jet outlets. **CAUTION: Use only Propylene glycol as your anti-freeze. This is non-toxic. NEVER use automobile anti-freeze since it is toxic.**
- f. Remove the pump drain plug located on the front of the pump housings. Allow all water to drain out. Place the drain plug in a reclosable plastic storage bag and store near the pump. Replace the drain plugs on start-up.
- g. Unscrew the suction/discharge pump and heater unions and allow the water to drain. Leave union loose. **NOTE:** Tighten unions before filling spa.
- h. Replace the equipment compartment door and secure with screws.

**Note:** Damage caused by improper winterizing will not be covered under warranty. You may want to contact Customer Service at (888) 961-7727 Ext. 8440 for complete winterizing instructions.

## TROUBLESHOOTING PROCEDURES

In the event the spa is not working the way it should, please first review all the installation and operating instructions in this manual and check the message on the panel display. If you are still not satisfied it is working properly, please follow the appropriate troubleshooting instructions.

### **CAUTION! WARNING! SHOCK HAZARD!**

#### **No User Serviceable Parts.**

Do not attempt service of the control box. Contact Customer Service for assistance. Follow all owner's manual power connection instructions.

### **NO COMPONENT OPERATION**

Check the following:

1. Is there power to the spa?
2. Is the household circuit breaker tripped?
3. Is the subpanel (230V) GFCI tripped?
4. If 1 is yes and 2 and 3 are no contact Customer Service for assistance.

### **PUMP DOES NOT OPERATE, BUT THE LIGHT DOES**

Press the *Jets 1 or 2* button:

The pump operates but no water flows to jets. Pump may not be properly primed. This can happen after the spa is drained and refilled. Press the *Jets 1 or 2* button several times, never leaving the motor on for more than 5-10 seconds at-a-time with no water coming of of jets.

### **POOR JET ACTION**

1. Press the *Jets 1 or 2* button to make certain the pump is on.
2. Turn the air control valves in one direction to increased jet action.
3. Make sure the water level is half way between top of spa and top of the gray filter ring.

4. Check for dirty filter. Clean, if necessary.
5. Make sure all jets are in the open position.







### **WATER IS TOO HOT**

1. Check desired temperature on topside control.
2. Check for a Diagnostic Message (in Control Panel Operation section).  
**OH** - Overheat (spa is deactivated) **DO NOT ENTER THE WATER.**

If the spa has overheated you should remove the cover to promote heat reduction. The spa control system should reset itself when the water temperature reduces below 104°F (40°C). When the spa falls below the reset temperature you can push any button on the topside control to reset the control system. Under extreme and/or prolonged weather conditions it is possible for the ambient temperature to exceed 106F (41C); effecting the water temperature of the spa and causing it to overheat. These conditions could cause the spa sensors to produce an OH message and prevent the usage of your spa during these conditions. The location of your spa should be reconsidered to reduce the outside temperature around the spa. For example, you may need to prevent direct sunlight on any surface of your spa. Regardless, do not enter your spa if the temperature is above 104°F (40°C).

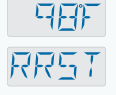
Should checking the above steps fail to correct the problem, please contact Customer Service at (888) 961-7727 Ext. 8440 or at [ahsservice@watkinsmfg.com](mailto:ahsservice@watkinsmfg.com).

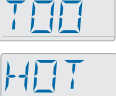
## TROUBLESHOOTING

Message	Meaning	Action Required
	No message on display. Power has been cut off to the spa.	The control panel will be disabled until power returns. Most spa settings will be preserved until next power up.
	The system has shut the heater off because the temperature at the heater has reached 118°F (47.8°C). <b>Do not enter the water!</b>	<b>DO NOT ENTER THE WATER.</b> Remove the spa cover and allow the water to cool down, then shut power off and power your spa up again to reset the system. If spa does not reset, shut off the power to the spa and contact your local Dealer.
	Set temperature will only reach 99°F	Go to page 12 and follow the instructions under Temperature Range to go to TR:HI
	This keeps flashing on the screen between water temp and REST and the water doesn't seem to be as warm.	The spa has been placed into REST mode where the heater will only come on during the filter cycles or when the Jet pump is activated. See page 12 under Heat Modes to change.
	This keeps flashing on the screen between water temp and RRST and the pump won't shut off	The jet pump button has been pressed during the REST mode and pump will run for 1 hour with the heater on (see page 12, Heat Modes)
	None of the buttons work but the power to the spa is on.	The spa is in LOCK mode, to unlock the control panel see page 14 to unlock the control panel.
	I can not change my set temperature when I press the Temperature button(s).	The spa is in TEMP LOCK mode, to unlock the TEMP LOCK see page 14.
	A Message comes up on the screen that is not listed in this Owner's Manual or functions that are available but are not listed in this manual can be found online in a supplement manual. Go to: <a href="https://cdn.shopify.com/s/files/1/0449/3839/5807/files/304573.24SUP_Rev_A_DPS_Lifesmart.pdf?v=1689980209">https://cdn.shopify.com/s/files/1/0449/3839/5807/files/304573.24SUP_Rev_A_DPS_Lifesmart.pdf?v=1689980209</a>	Scan QR Code below to find the supplement control manual online:  

# REPLACEMENT PARTS

## REPLACEMENT SPA PARTS

<b>PART NUMBER</b>	<b>DESCRIPTION</b>
1019401	SPA FILTER – 50 sq. ft.
77190	OZONE KIT (INCLUDES ALL MATERIALS)
303574	OZONATOR
79640	3 INCH JET
79641	5 INCH JET
78419	MINI JET
79706	CONTROL PANEL (1 PUMP)
79634	CONTROL PANEL (2 PUMP)
79648	CHARCOAL PILLOW
79649	AIR CONTROL VALVE
79651	LIFESMART OVERLAY (1 PUMP)
79704	LIFESMART OVERLAY (2 PUMP)
71515	COVER LOCKS
70322	COVER KEYS

life  smart™

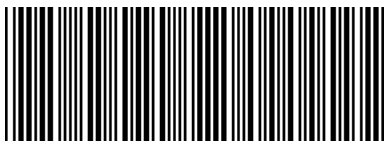

\*304573.24\*



304573.24 B (9/23)